

Innovation/Technology/High Quality



IP65
SOLAR PUMPING
INVERTER

ShenZhen VEIKONG Electric CO., Ltd.

Factory Address: Block E01, first industrial park lingbei 5 road ,
phoenix community, fuyong street , Bao'an District, Shenzhen , China

Technical Support Hotline: +86-0755-89587650
Web Site: www.veikong-electric.com

ShenZhen VEIKONG Electric CO., Ltd.
VEIKONG INDUSTRIAL CO., LIMITED (HK)

APPEARANCE



Front

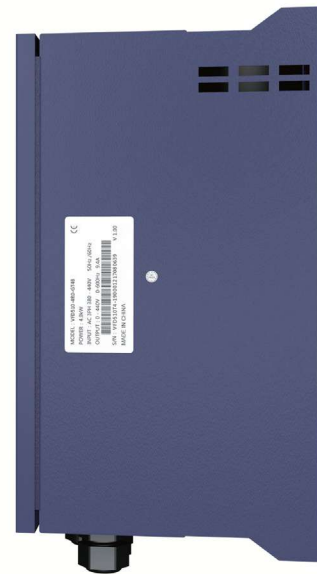

Left



Back



Top



Bottom

INTRODUCTION

VFD510-PV solar pump drive is a high protection water-proof grade inverter for water pump . The product has excellent software performance and MPPT function to be adaptive to all cloudy weather to get maximum power and water output. The robust hardware is designed with high reliability and user-friendly operation . VFD510-PV solar pump inverter can be used for all kinds of Solar pump system can be applied in area with sunshine and areas lack of electricity., especially suitable for occasions that have strict requirements on system cost, reliability, and use environment.

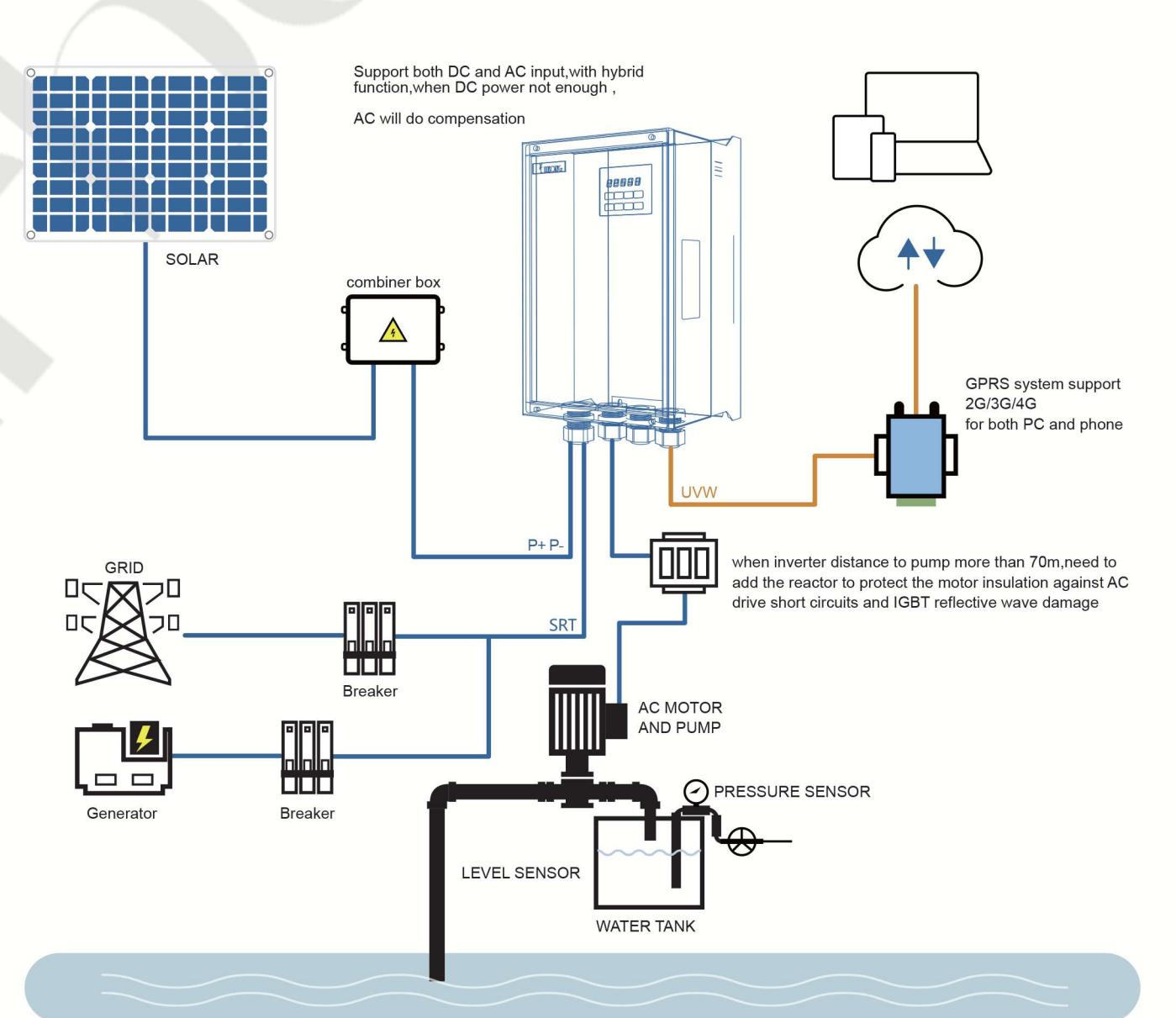

ADVANTAGE

VEIKONG VFD510-PV solar pumping inverter is specially designed for watering system. A high converting efficiency of 99% and advanced MPPT technology make the solar energy fully used. It converts DC power into AC to drive all kinds of motors. The intelligent design protects the pumps from many abnormal cases, such as over-loading, over-voltage, dry-running, over-heating, low frequency and etc.

PRODUCT FEATURES

01. Operates without grid directly from photovoltaic (PV) cells ;
02. Automatic start and stop with solar radiation ;
03. Built-in maximum power point tracking (MPPT) ;
04. Easy installation and set-up for serial production ;
05. Compatible with all pump types ;
06. Dual supply capability with change over switch - solar and grid compatible ;
07. Energy saving function and dry run self-learning function ;
08. Strong anti-interference ability, convenient for inverter assembly ;
09. IP65 protection grade, adapt to various harsh indoor and outdoor environments.

10. GPRS monitoring control via PC and Mobile

VEIKONG solar pump inverter GPRS system is a professional monitoring system platform managing solar pump plants.

It supplies water volume monitoring and operation of inverter from anywhere at anytime.

It's convenient to visit real time and historical data via web or IOS & Android APP anytime and anywhere.

This easy-to-use platform makes monitoring of solar pump systems simple and convenient, far reducing operate time and monitoring costs as well.



Installation and terminal connection

Terminal	drive	Gprs module
Power terminal	24+	VCC
	COM	GND
Communicational	485+	TX1/A1+
	485-	RX1/B1-

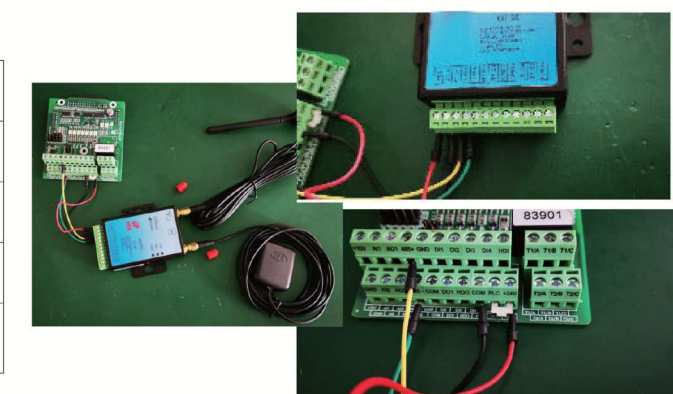

GPRS operation

Remote control and monitor from PC side

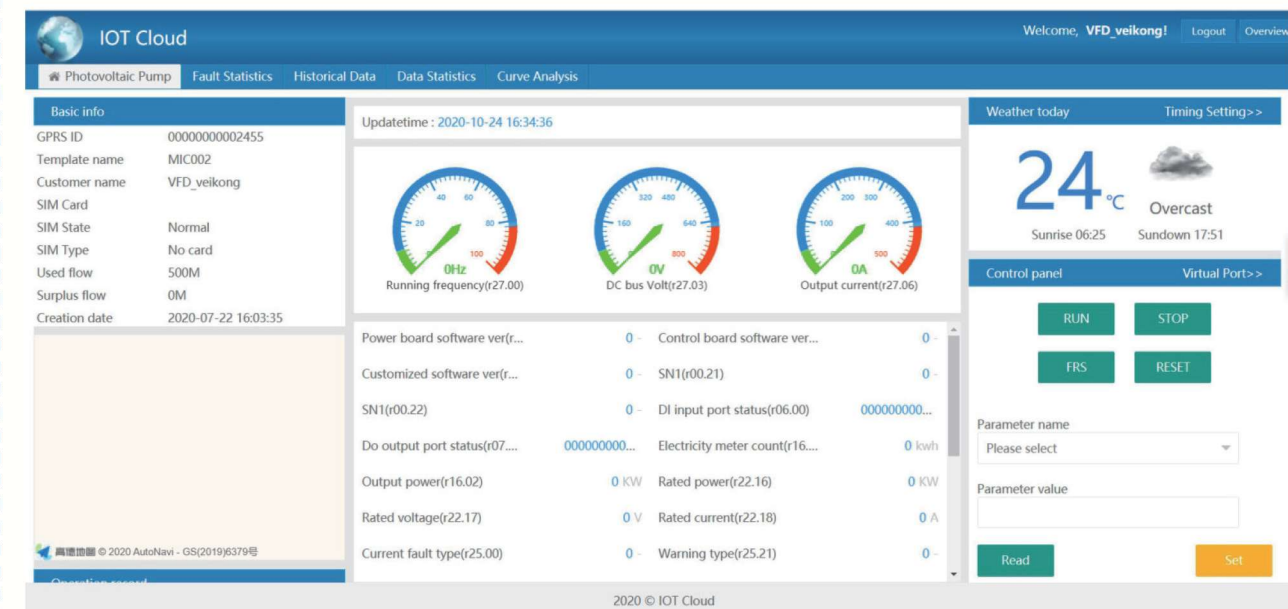



Remote control and monitor from mobile phone side

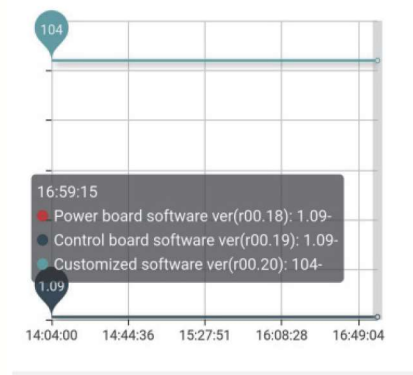
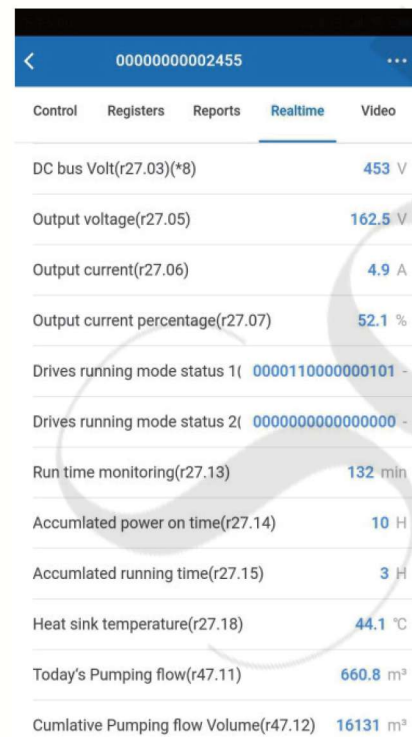
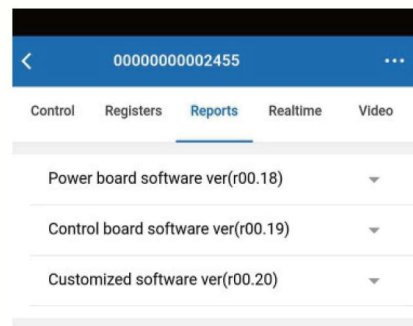
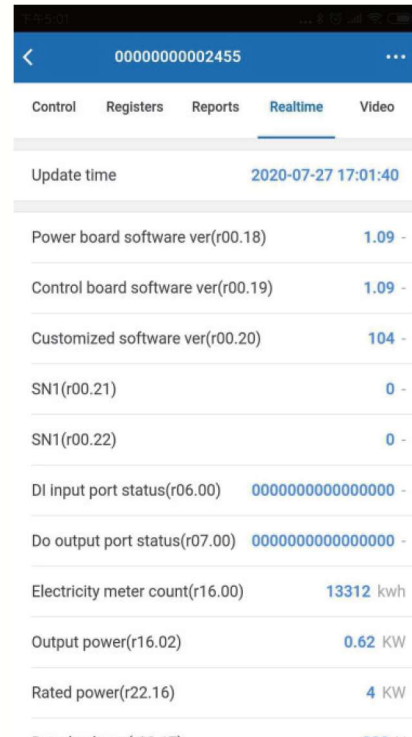
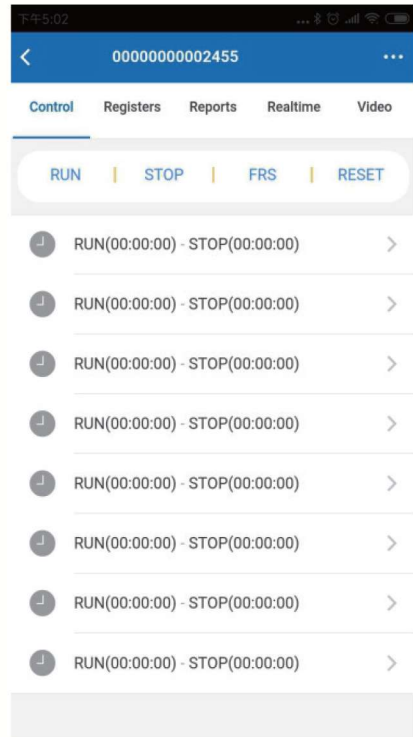

APPLICATION OCCASIONS



TECHNICAL SPECIFICATIONS

	220V	380V
Max input DC voltage(VOC)	450V	800V
DC voltage range	200~450VDC	350~800VDC
Recommended DC input voltage range (Vmpp)	250V-400V	450V-600V
Recommended Input Operation Voltage	305V(Vmpp)	530V(Vmpp)
MPPT efficiency	>99%	
Rated output voltage	1/3-phase 220VAC	3-phase 380-480VAC
Output frequency range	50/60Hz	
Max efficiency of the machine	99%	
Ambient temperature range	-10 °C~50 °C, derating if the temperature is above 40 °C	
Cooling method	Air cooling	
Protection degree	IP65	
Altitude	Below 1000m; above 1% for every additional 100m.	
Standard	CE/ROHS	

Drive model	Max DC input current (A)	Rated output current (A)	Applicable water pump (kW)
VFD510-40T00400-PV	16.5	9.4	4
VFD510-40T00550-PV	23.9	13	5.5
VFD510-40T00750-PV	30.6	17	7.5
VFD510-40T01100-PV	39.2	25	11
220V single phase/three phase level			
VFD510-20T00220-PV	14.1	10.6	2.2
VFD510-20T00400-PV	22.6	17	4

Noted:

We suggest solar panel power should be 1.4-1.5 times higher than solar pump power ,and solar pump inverter power should be higher level than solar pump. When solar pump distance to inverter higher than 100m,it should be equipped with Output reactor or higher level power inverter .for Solar panel,I total VOC less than Maximum DC voltage of inverter and Solar panel vmp is recommend 530V for 380V pump and 305V for 220V pump

PRODUCT APPEARANCE AND INSTALLATION DIMENSION

PRODUCT APPEARANCE

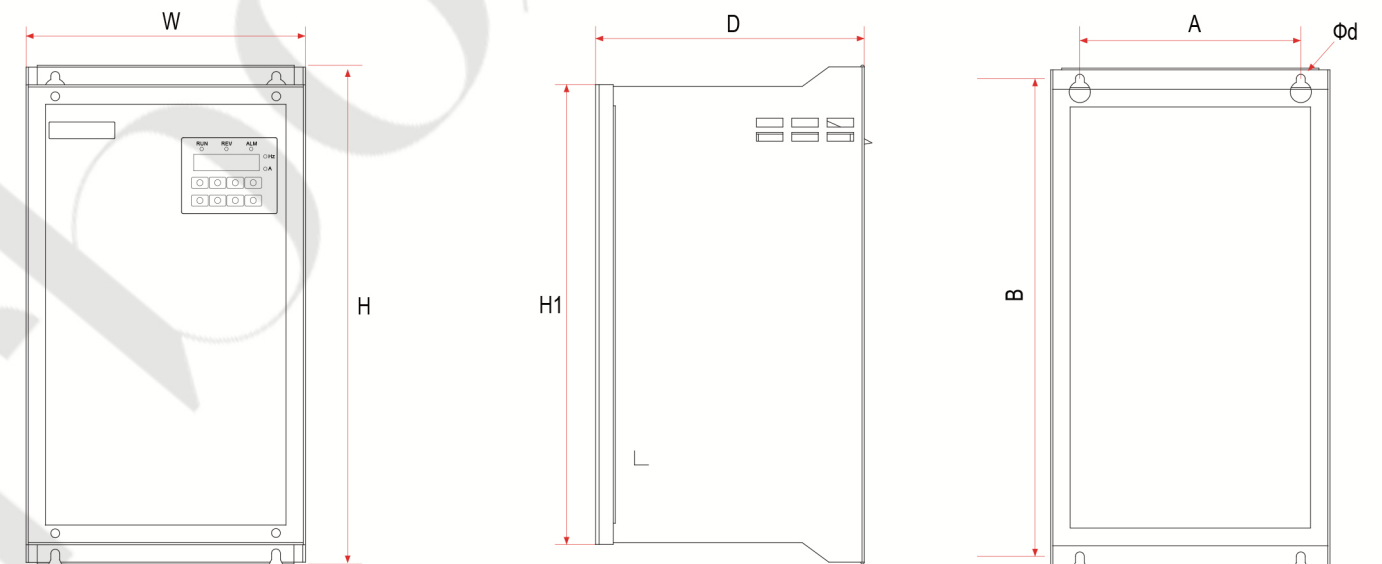

INSTALLATION DIMENSION

SIZE	MODEL	Appearance and installation dimension (mm)							
		A	B	H	H1	W	D	ød	Mounting screws
SIZE A	VFD510-40T00400-PV	125	270	282	260	158	152	ø5.0	M4*16
	VFD500-40T00550-PV								
SIZE B	VFD500-40T00750-PV	120	305	318	292	170	170	ø5.0	M4*16
	VFD500-40T01100-PV								

STANDARD WIRING DIAGRAM

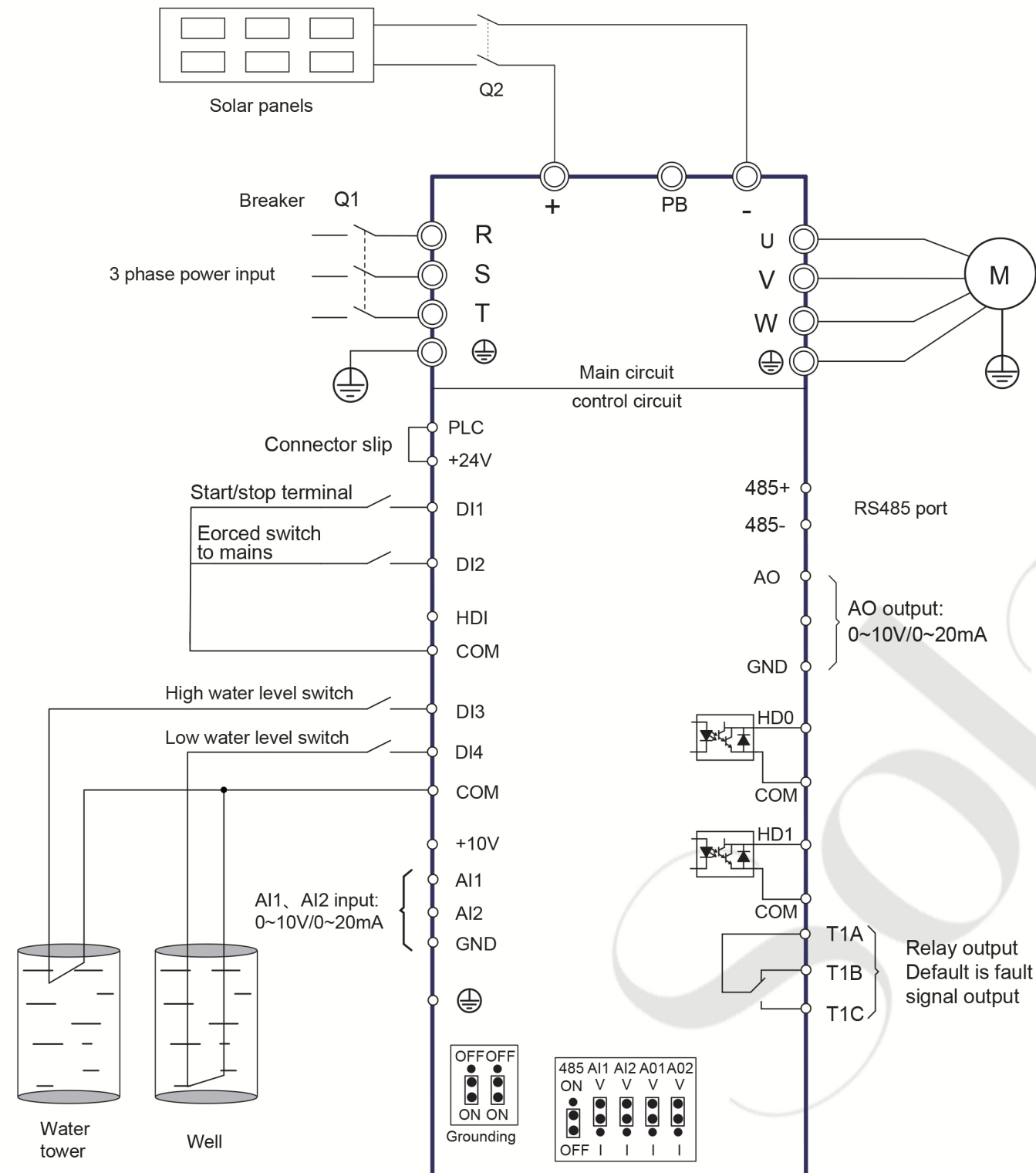

NOTE:

- 1: VFD510-PV Solar array output should be connected to the terminal (+DC, -DC) of the drive, please pay attention to the polarity of the solar array or you can connect solar array to R and T
- 2: For control wire, recommend using shielded cable or shielded twisted pair.
- 3: Do not suggest using the power contactor to control the RUN/STOP of the drive.
- 4: In default carrier frequency, the maximum motor cable length is 100 meters. When the motor cable is longer than 70m, it is recommended to use output reactor.

For 220V single phase motor connection

